

TTL IC PINOUTS

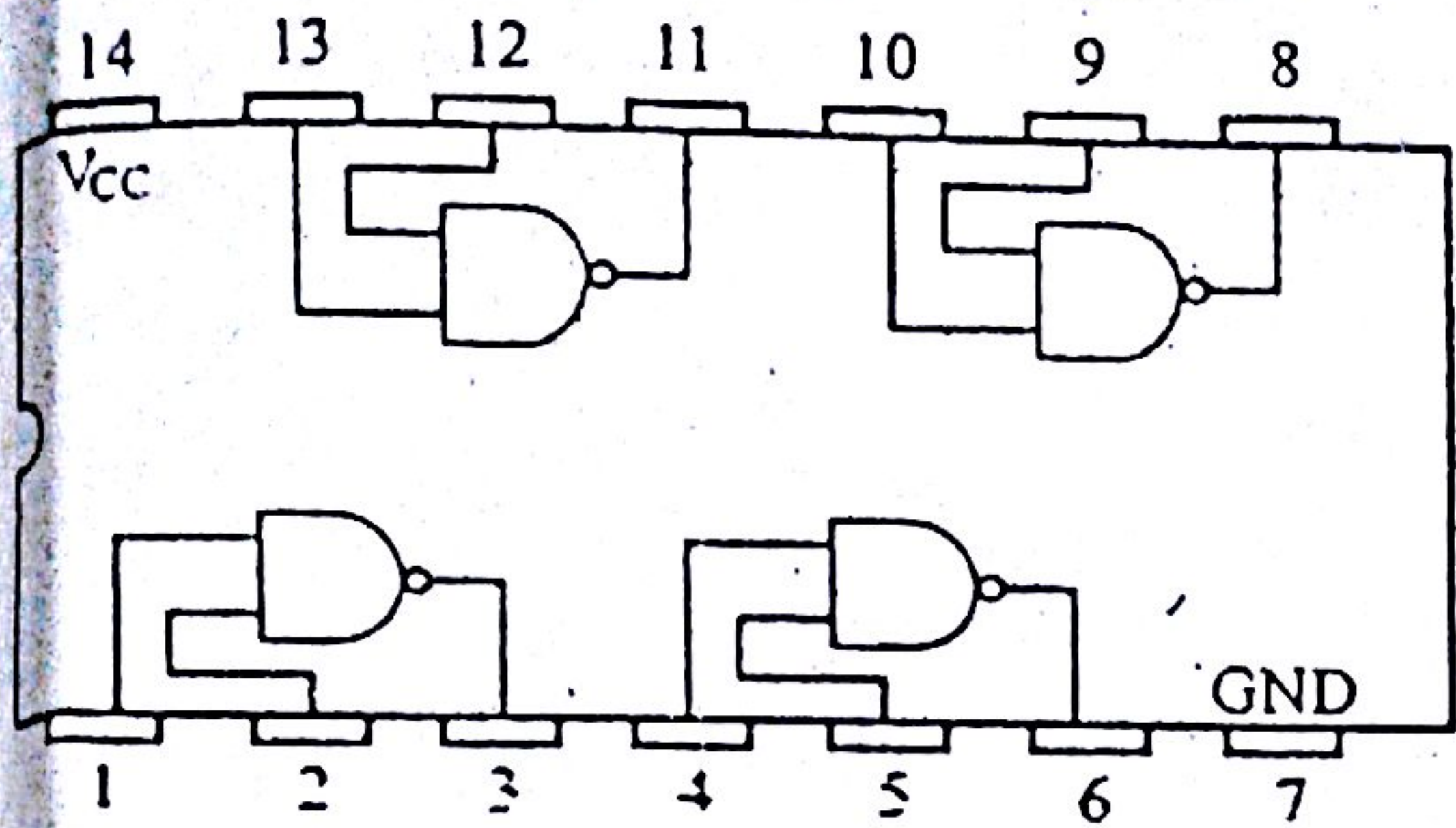

7400

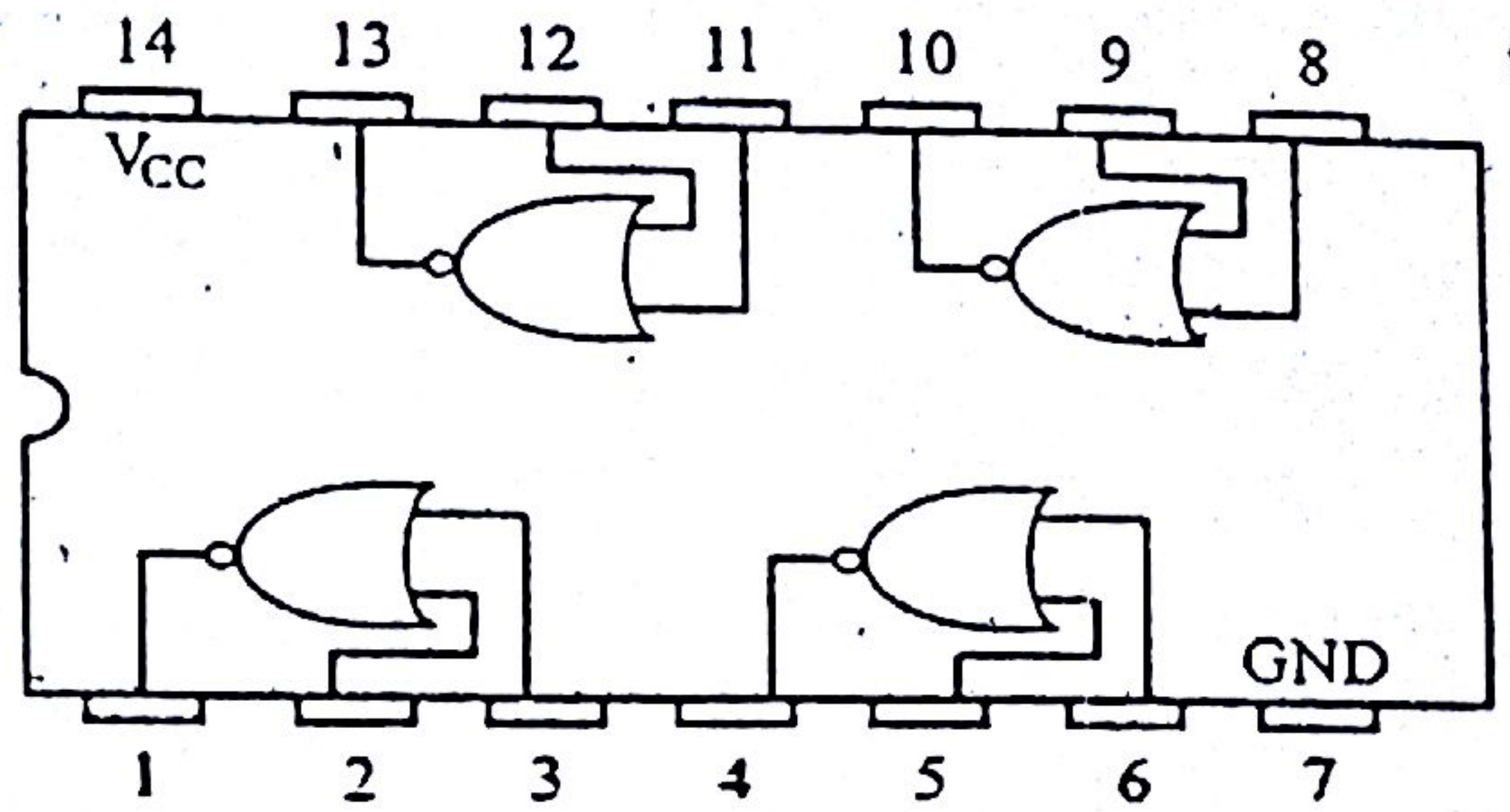

7402

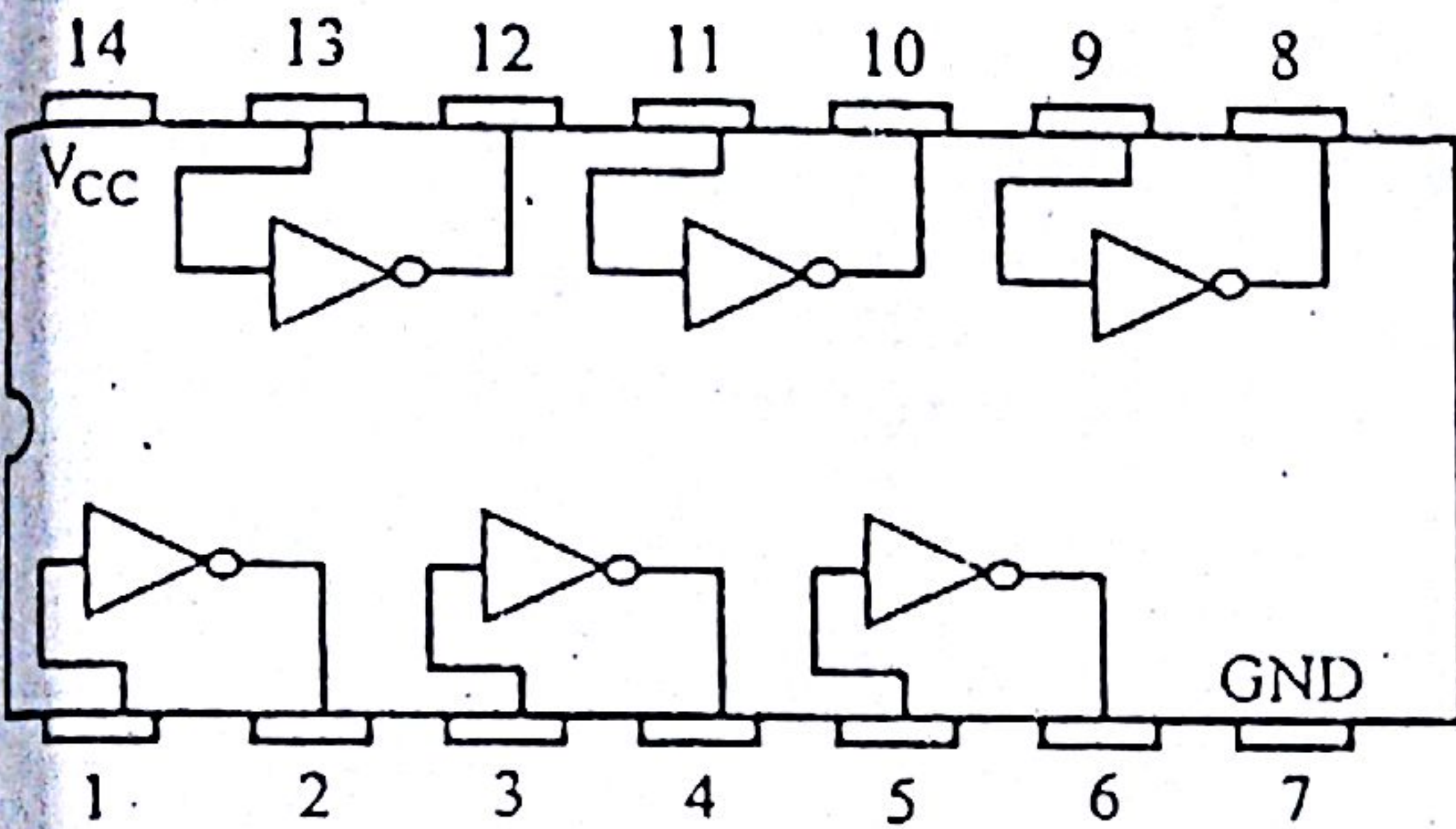

7404

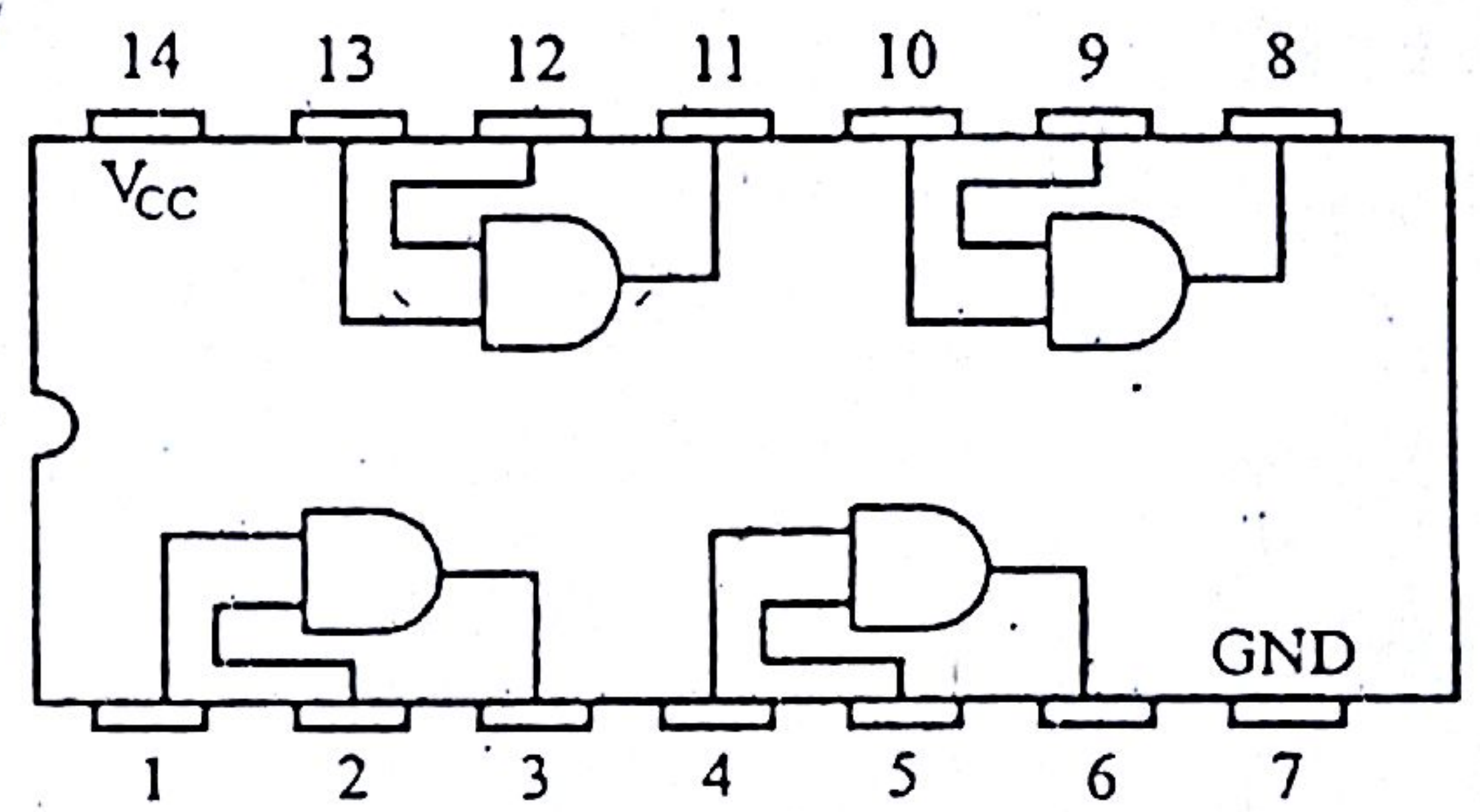

7408

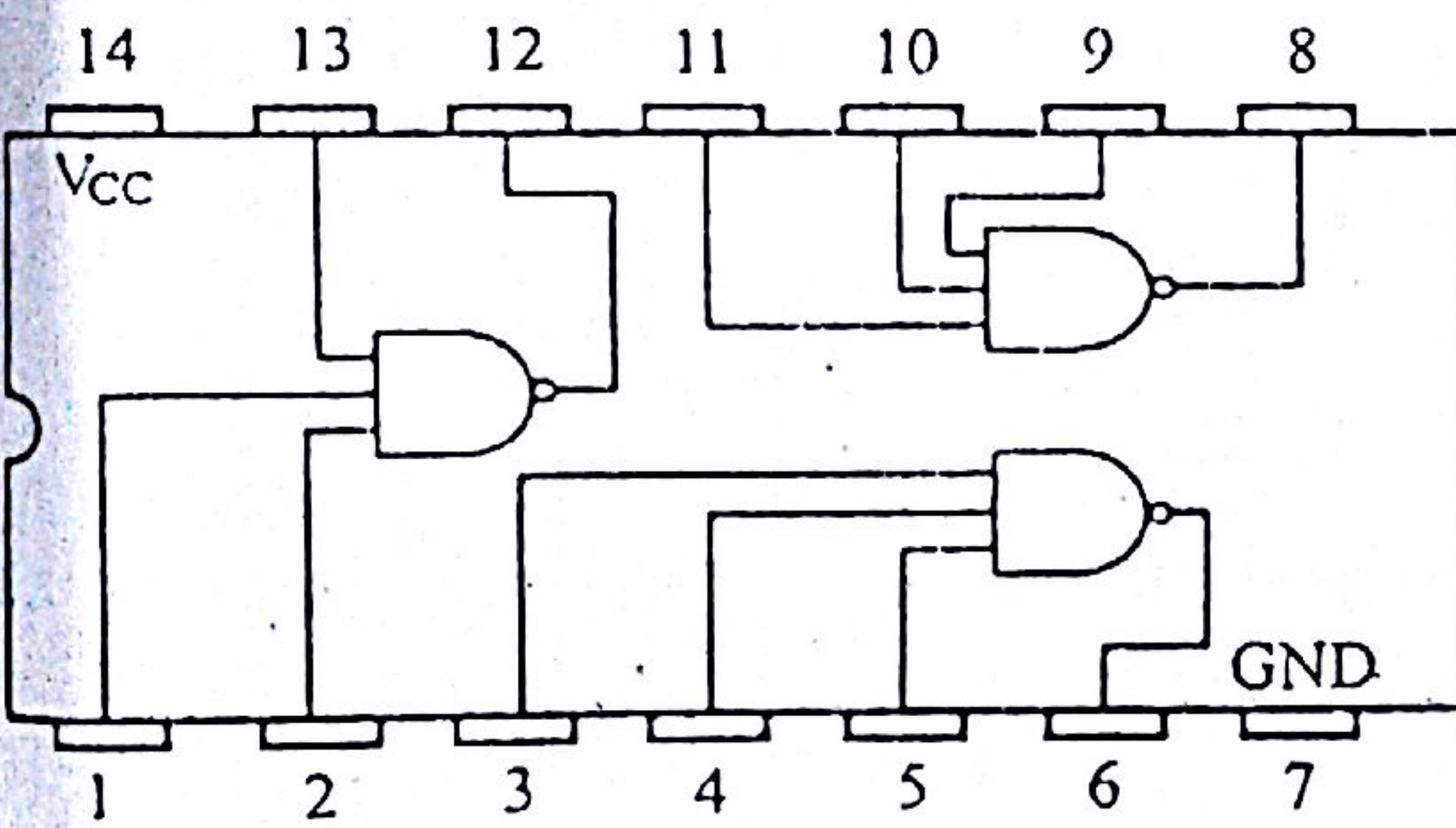

7410

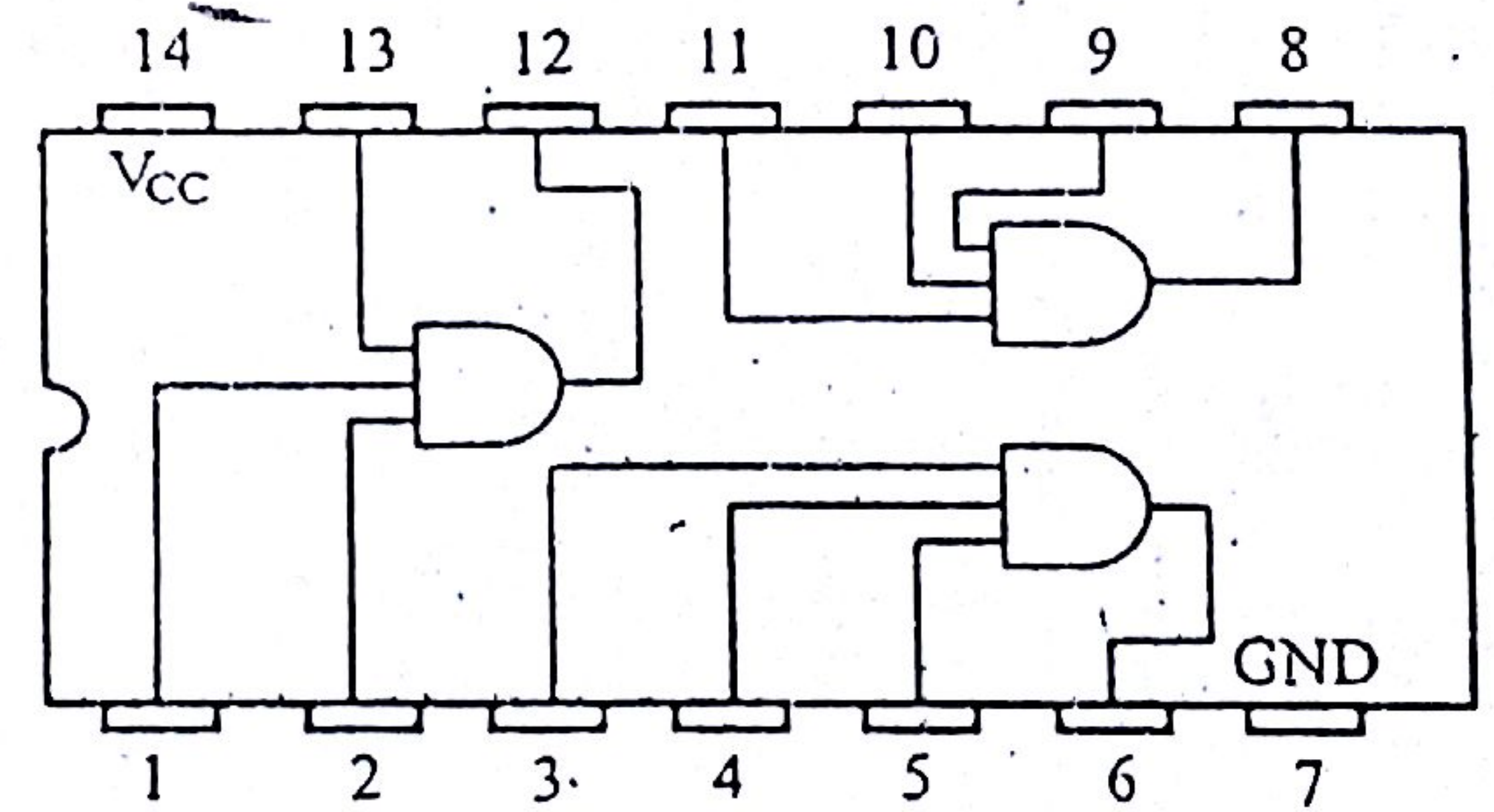

7411

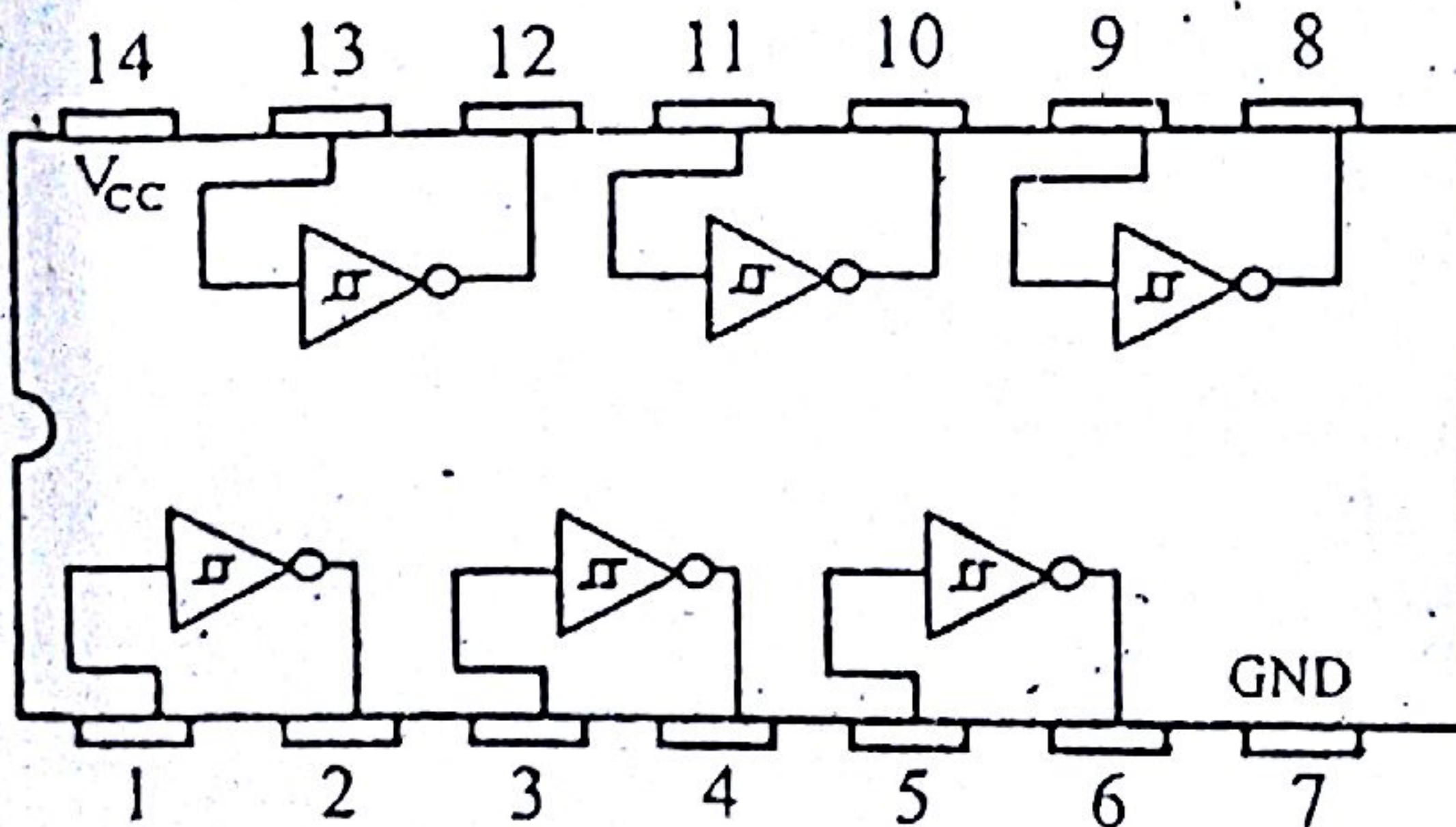

7414

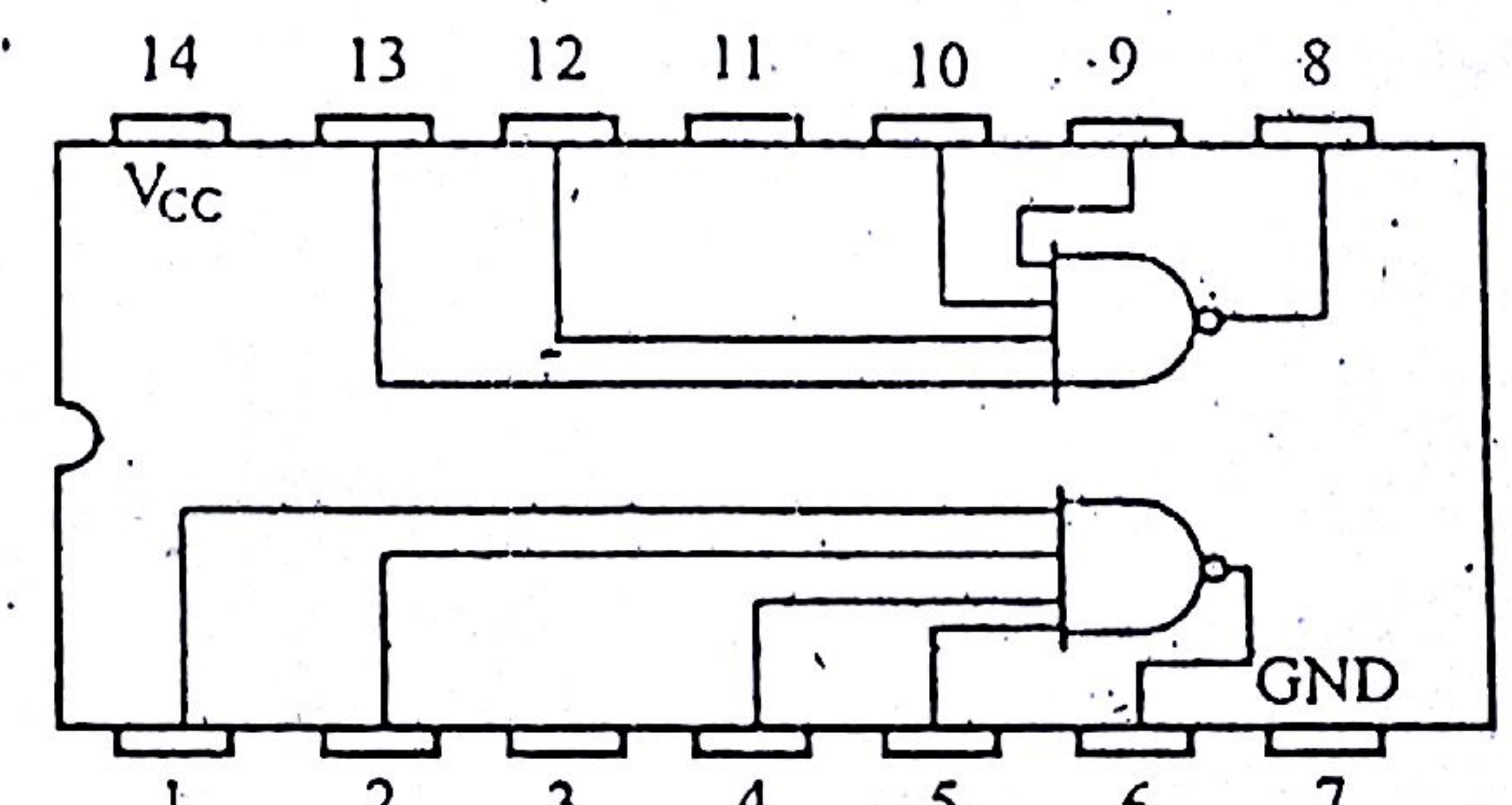

7420

